

WIRING FOR ARCODE ELEVATOR CONTROL SYSTEM



ARKEL

Arkel products (Arcode, ADrive, ARL 300, ARL-700, Arem etc.) are available at ISF Elevator Shop,
the online store of ISF Elevator GmbH.

System Overview

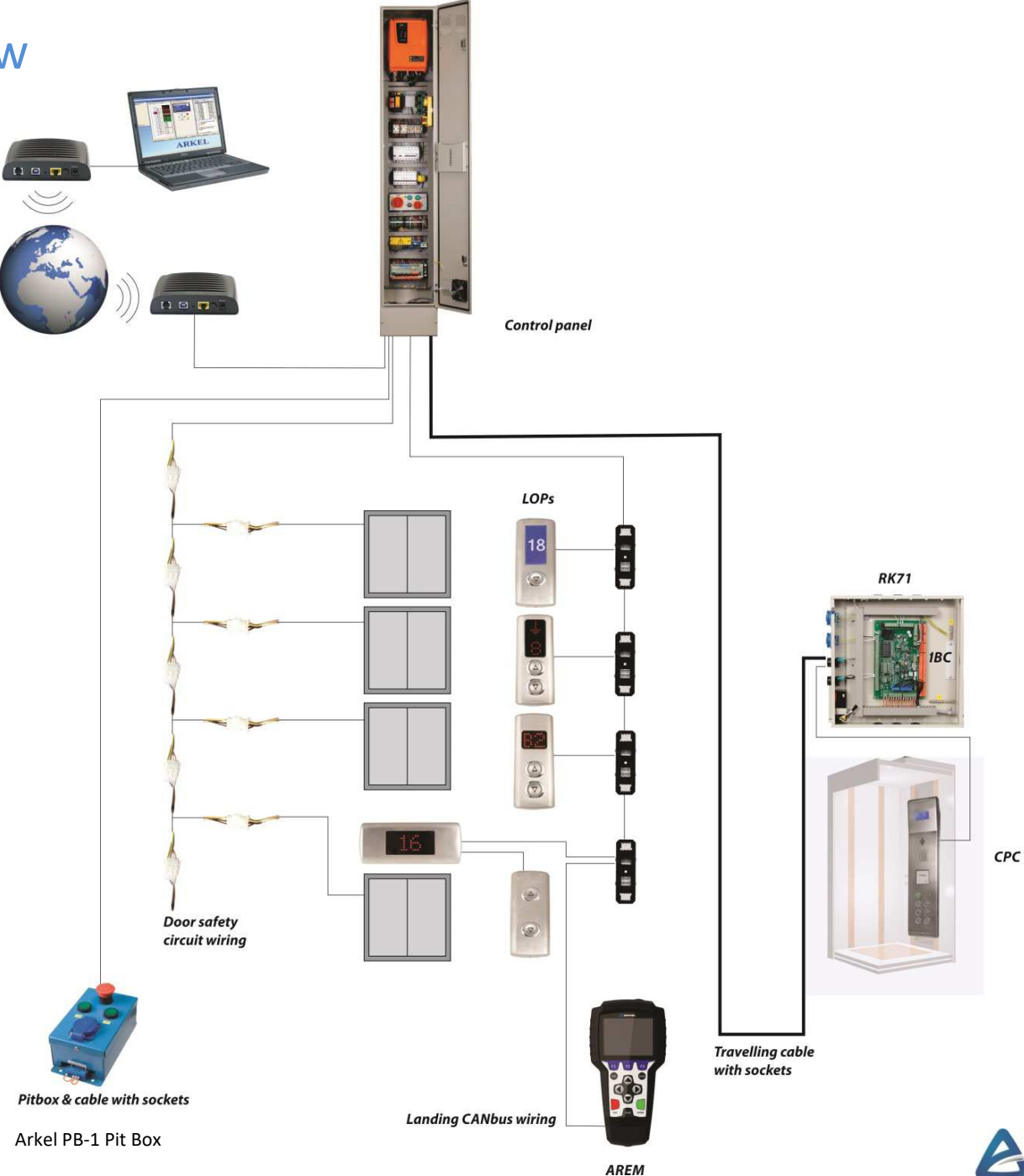

Arkel PB-1 Pit Box

Landing CANbus wiring

AREM



Car Installation

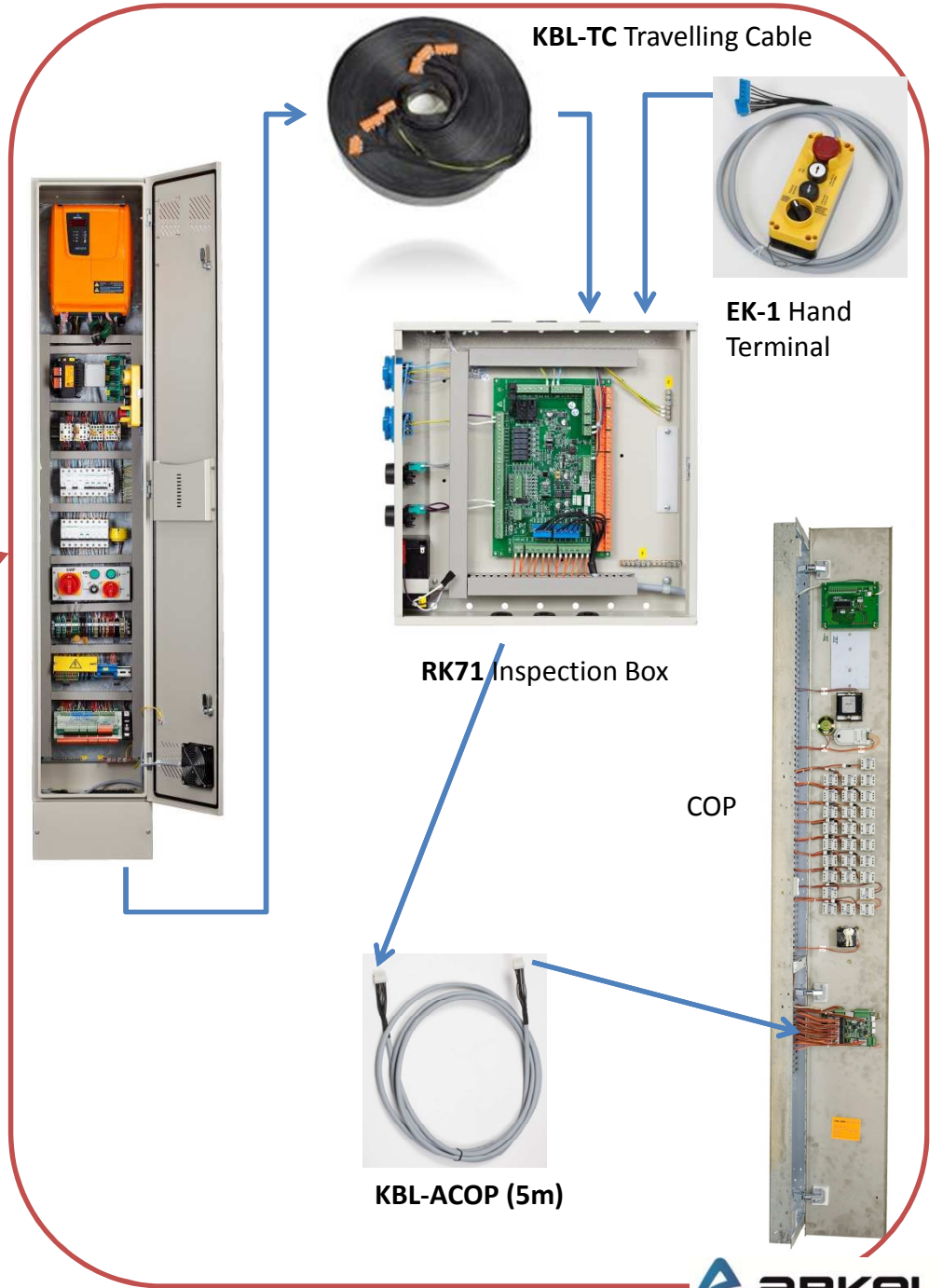
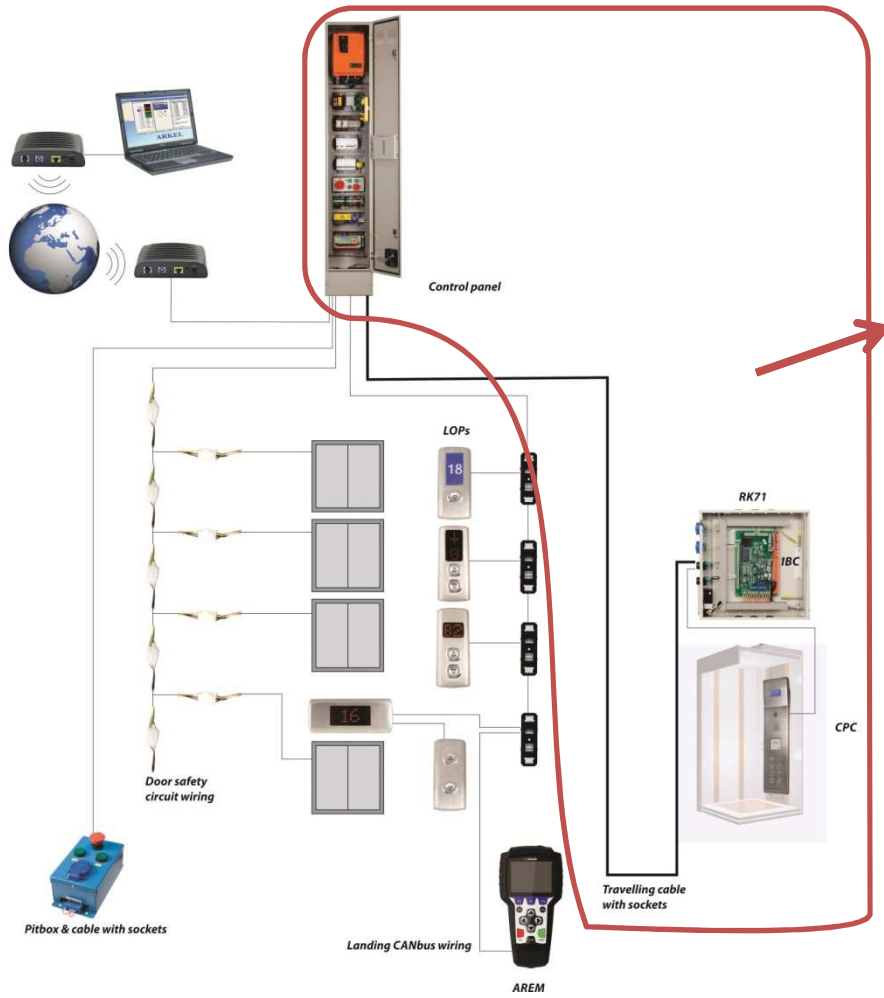

Landing Operation Panel Installation

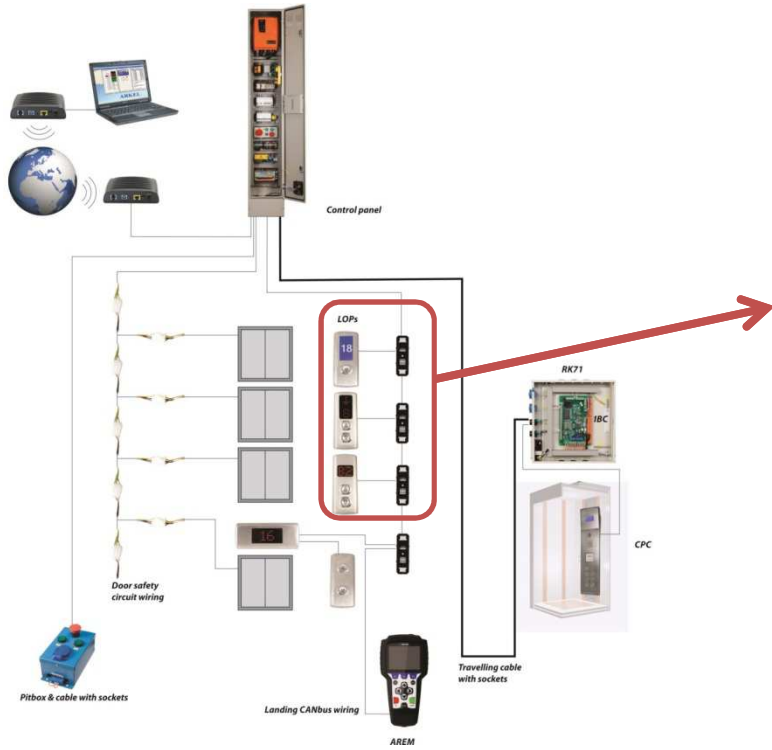

KXCBA : CANbus Junction

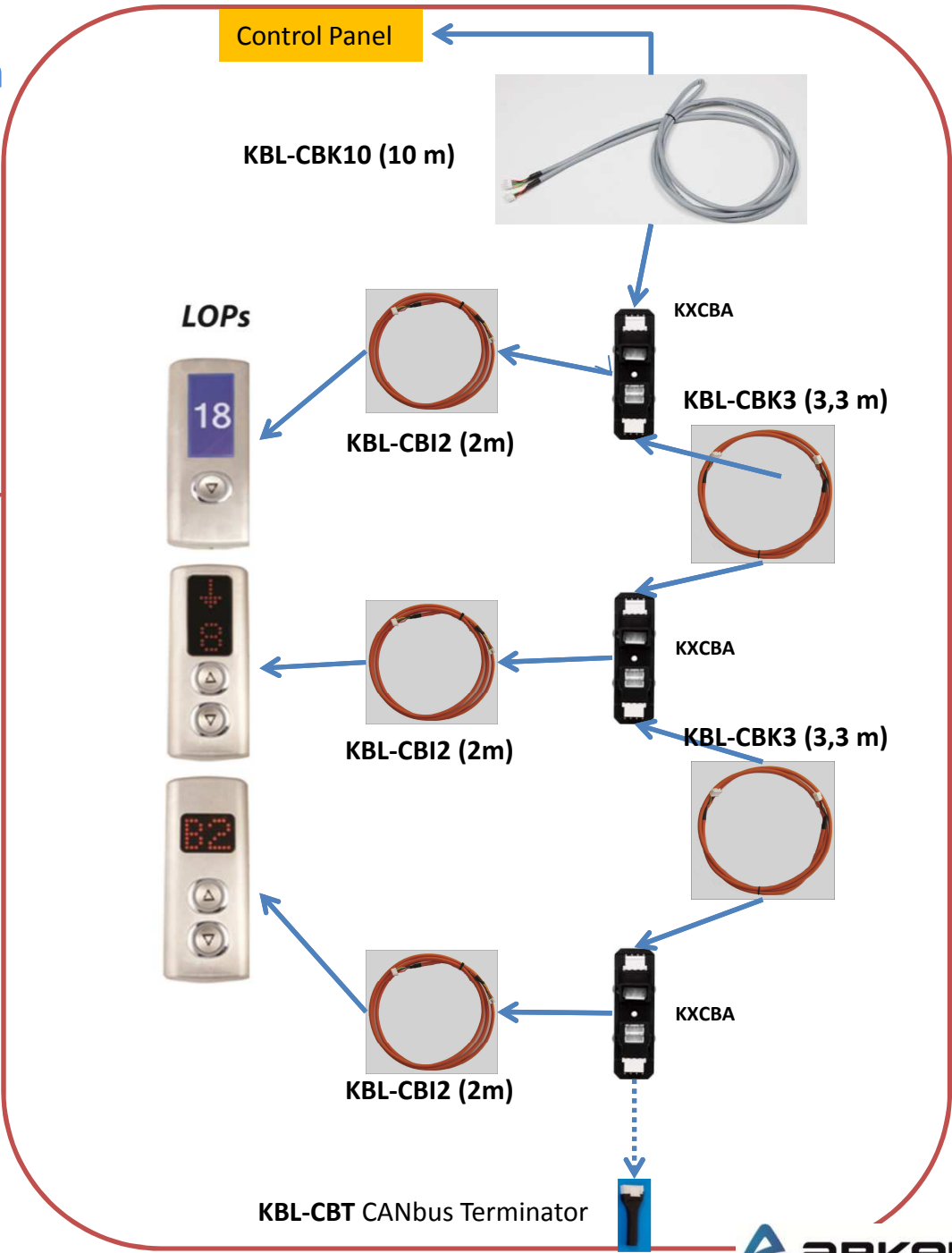

Door Contacts Installation

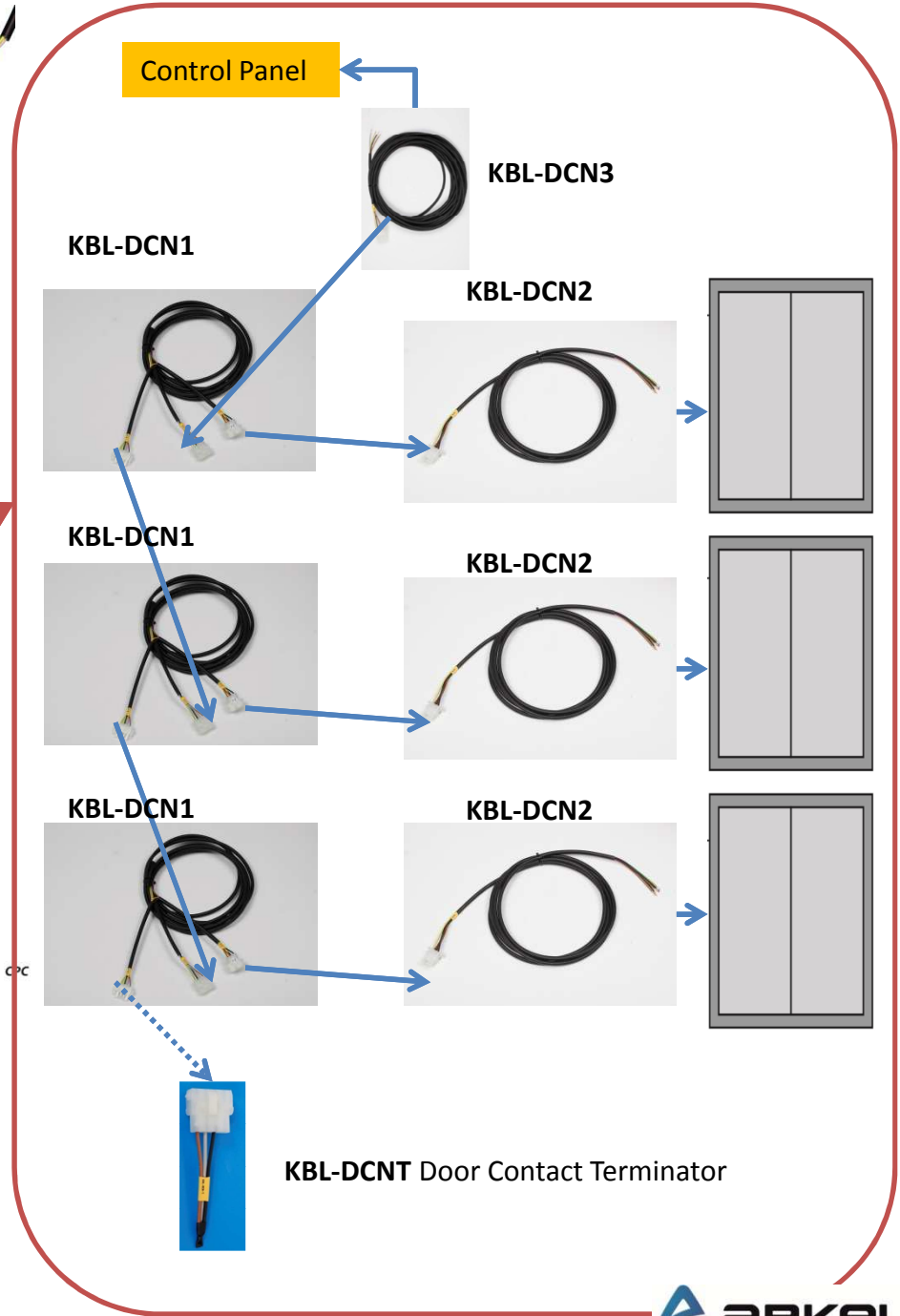
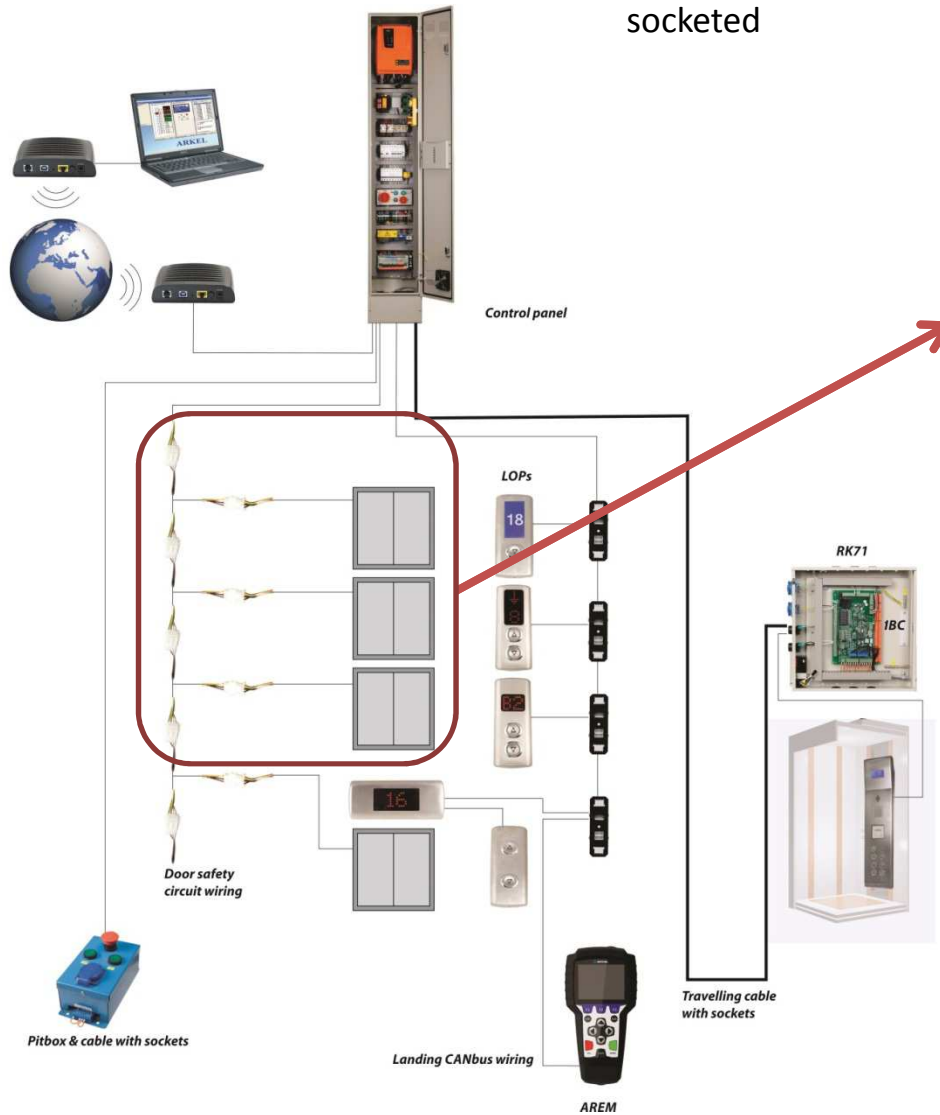
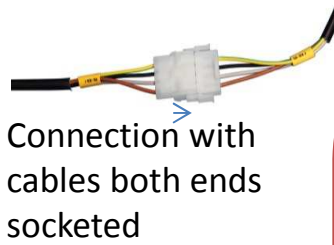

Pit Box Installation

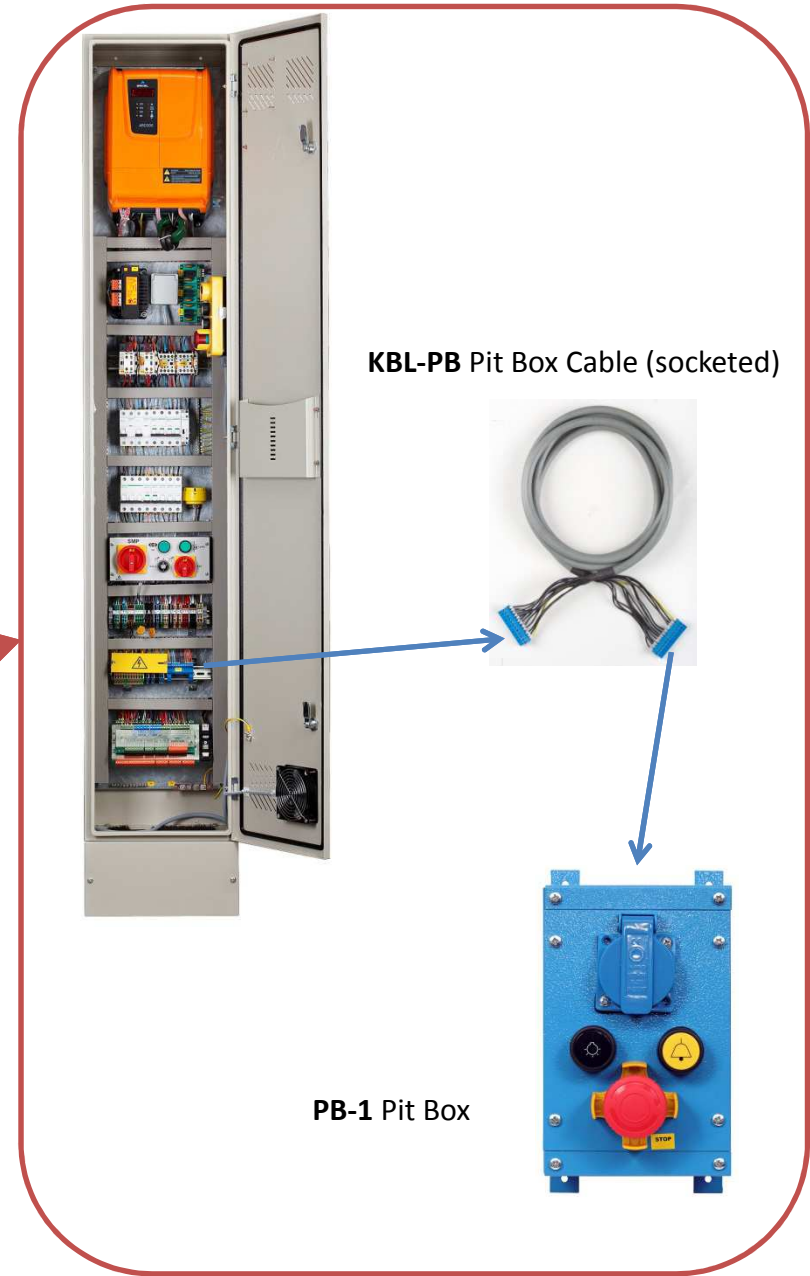
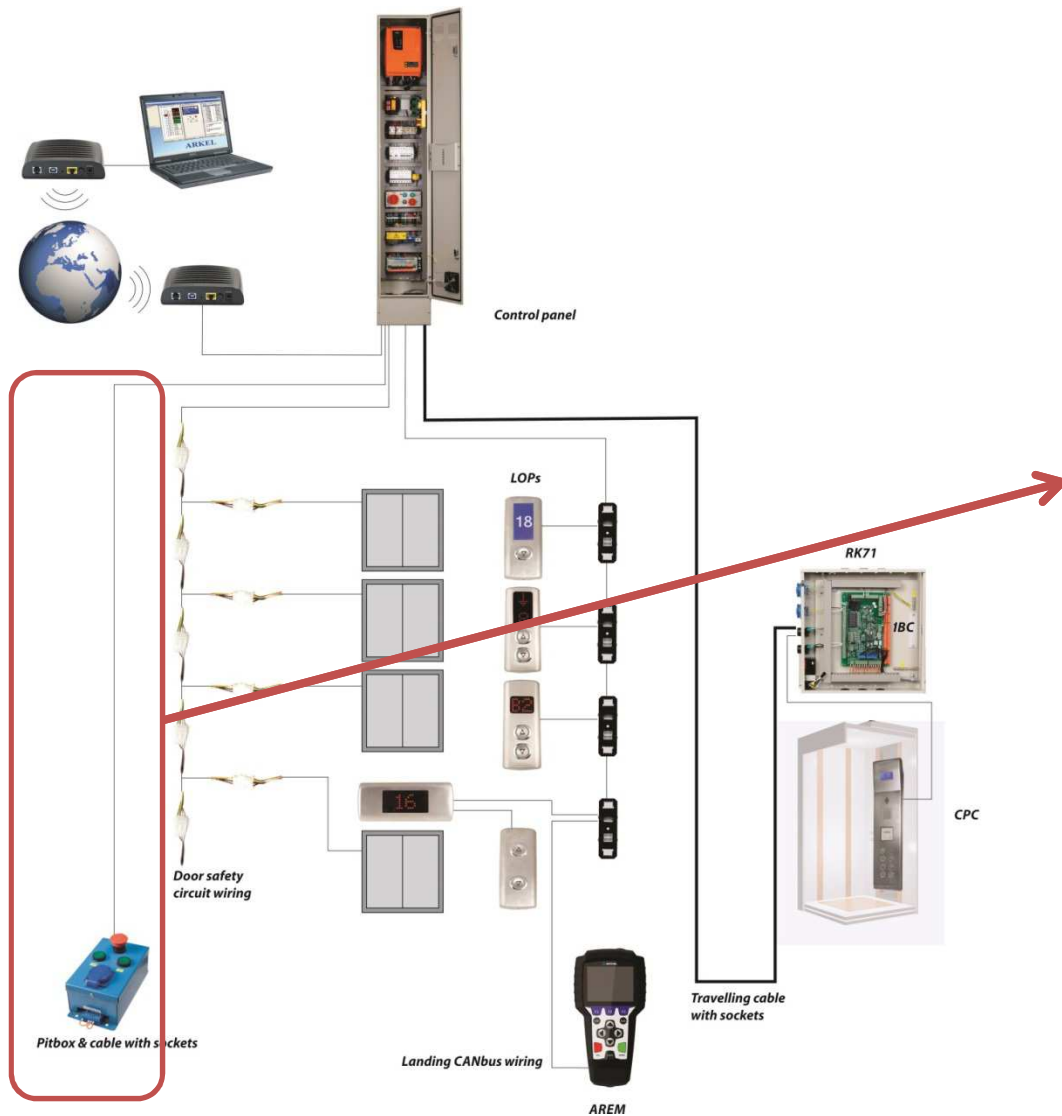

Car Operation Panel (COP) Installation

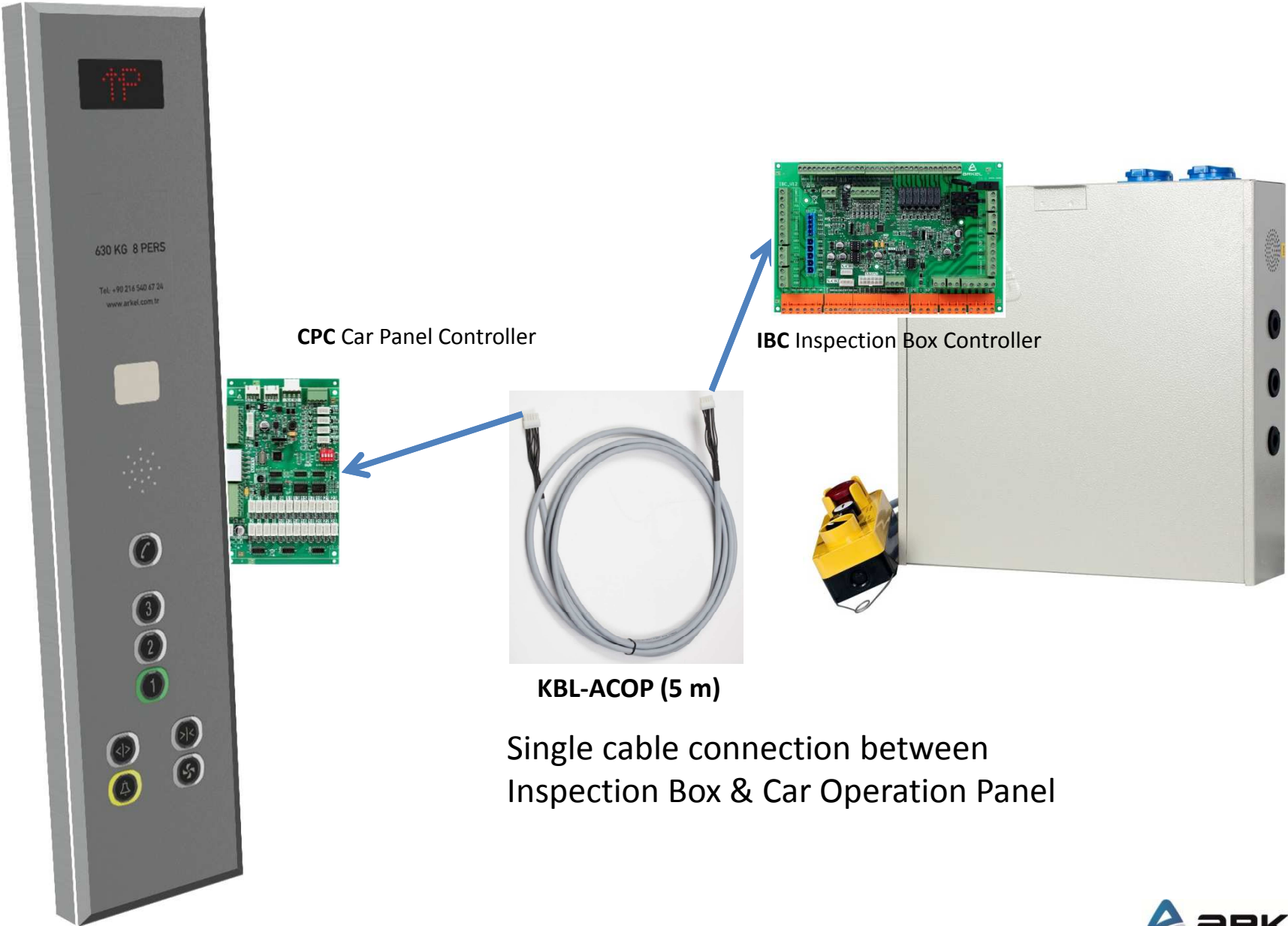

Landing Operation Panel Connections

BC-D2X

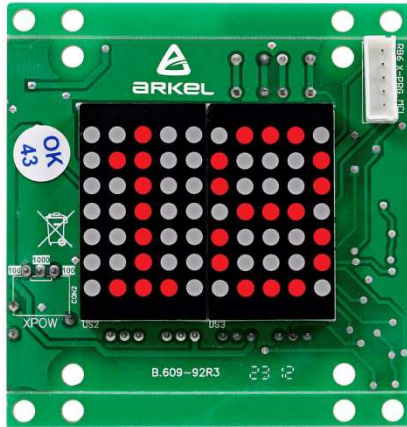

KBL-BT0

KBL-BT1

Button Cables



KBL-BT0	Button Cable 5cm (One End With Male Connector)
KBL-BT1	Button Cable 15cm (Two End With Female Connectors)
KBL-BT2	Button Cable 50cm (Two End With Female Connectors)
KBL-BT3	Button Cable 100cm (Two End With Female Connectors)
KBL-BT4	Button Cable 150cm (Two End With Female Connectors)
KBL-BT5	Button Cable 200cm (Two End With Female Connectors)
KBL-BT6	Button Cable 300cm (Two End With Female Connectors)

Easy connections through button connectors

Car Operation Panel Connections (Inside)

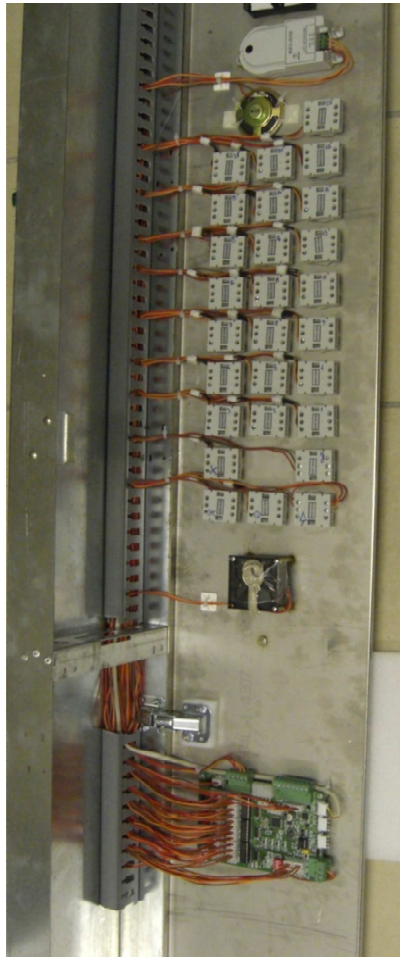

Ready made button connections

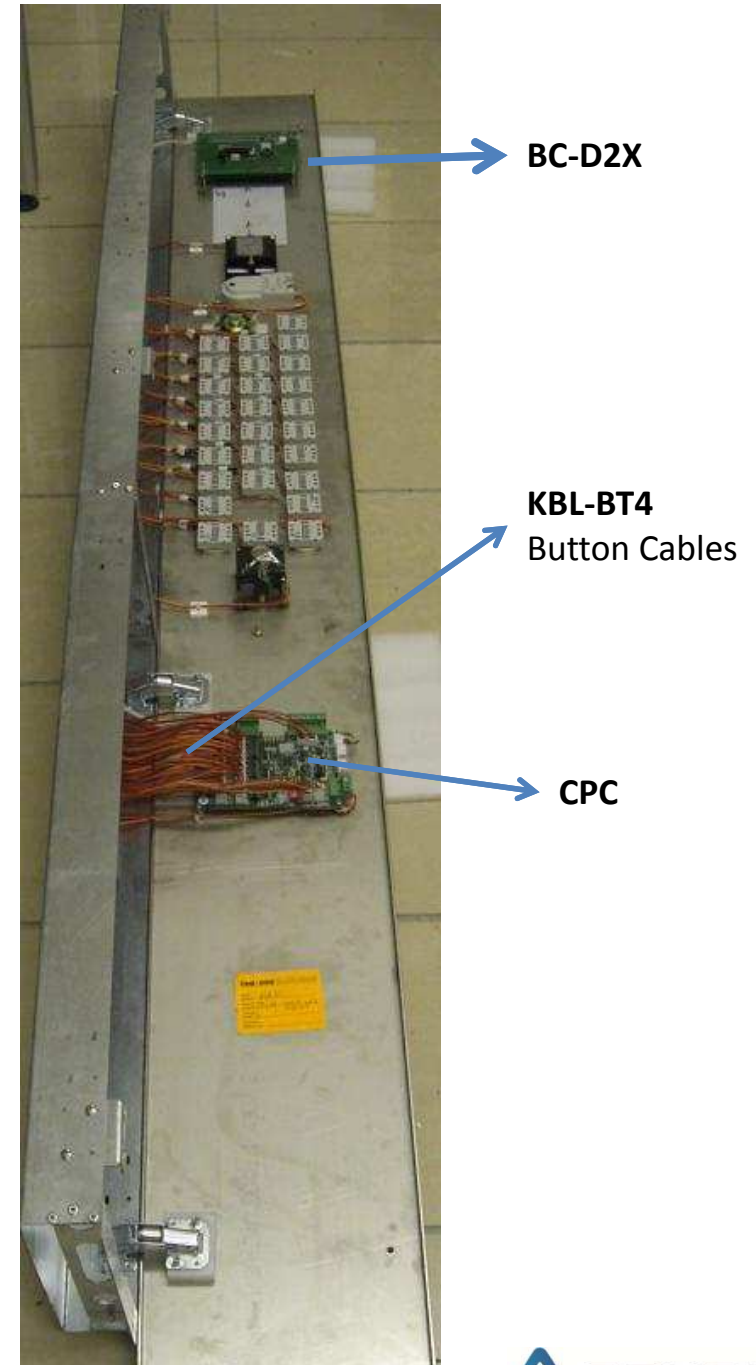

Example of Cable Calculation

Number of Stops = 3

Travel Height = 6 m.

(Single Cabinet)

	CABLE DESCRIPTION	QTY
CANbus WIRING	KBL-CBK10 / CAN BUS CABLE MAIN LINE 10 M.	1
	KBL-CBK3 / CAN BUS CABLE MAIN LINE 3,3 M.	2
	KBL-CBI2 / CAN BUS CABLE 2M. CONNECTION TO LOP'S	3
	KXCBA / CAN-BUS JUNCTION	3
	KBL-CBT / CAN-BUS LINE TERMINATOR	1
DOOR CONTACT WIRING	KBL-DCN1 / DOOR CONTACTS CABLE 4m.(MAIN LINE)	3
	KBL-DCN2 / DOOR CONTACTS CABLE 2m.	3
	KBL-DCN3 / DOOR CONTACTS CABLE 10m.(MAIN LINE)	1
	KBL-DCNT / DOOR CONTACTS LINE TERMINATOR	1
COP CABLE	KBL-ACOP	1
PIT WIRING	KBL-PB	18 m.
TRAVELLING CABLE	KBL-TC / (2x18x0,75mm2)	21 m.
BUTTON CABLES*	KBL-BT0	# of buttons on COP + # of buttons on LOP
	KBL-BT1	# of buttons on LOP
	KBL-BT2 / KBL-BT3 / KBL-BT4 / KBL-BT5 / KBL-BT6 **	# of buttons on COP

*BUTTON CABLES MAY DIFFER ACCORDING TO THE NEEDS OF SYSTEM DESIGNS

**DEPENDING ON THE COP HEIGHT

ARCODE Peripherals

BC-BUT



BC-D2X



BC-D3X



BC-LCD

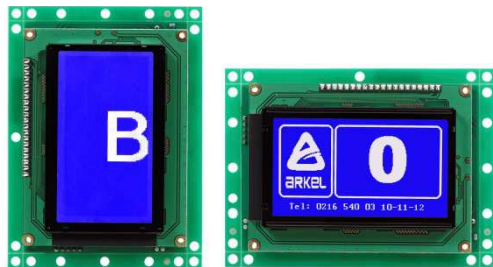

LCD240X128A



LiftMedia



ARCODE Shaft Lighting With Connectors

21W 120cm Fluorescent Lamp



Control Panel

KBL-SL10 (10 m)



KBL-SL2 (2.1 m)

